

MEASUREMENT OF KNOTS

201-a. Unless otherwise specified, knots shall be measured as the average of the maximum and minimum diameters as shown in Figure 1.

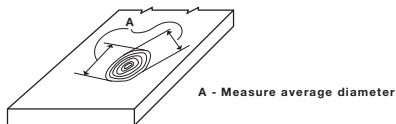

FIGURE 1

201-b. In Grades of Studs, Light Framing, Structural Framing and other grades where specified, knots on wide faces are measured between lines parallel to the edges as shown in Figure 2. When tapering knots are encountered, their equivalent displacement is determined as shown in Figure 3. Narrow face and spike knots are judged by the amount of cross section they occupy as illustrated in Figures 4 and 5.

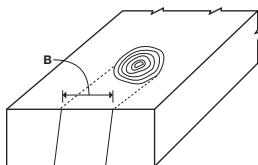

FIGURE 2

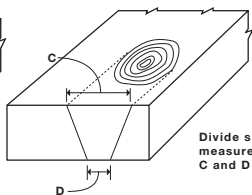
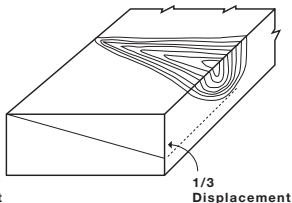
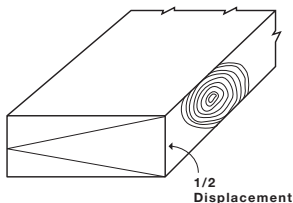

FIGURE 3



MEASUREMENT OF KNOTS

201-c. In Beam and Stringer grades, knots shall be measured as shown in Figures 6 and 7.

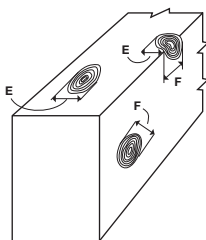

FIGURE 6

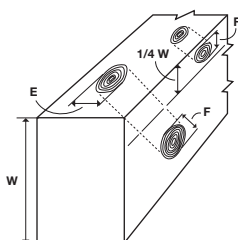

FIGURE 7

E - Measure between lines parallel to the edges.

F - Measure least dimension.

201-d. In Post and Timber grades, knots shall be measured as shown in Figure 8.

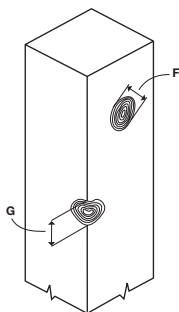

FIGURE 8

F - Measure least dimension.

G - Measure along corner or measure size most nearly representing diameter of branch causing the knot.

SHAKES, CHECKS AND SPLITS

202. Due to the nature of shakes, checks and splits, judgment must be used in evaluating their extent.

I. BEAMS AND STRINGERS.

The measurement of shakes, checks and splits is confined to the middle 1/2 of the height of the piece and restrictions on checks are applied only for a distance from the ends equal to three times the width of the wide face.

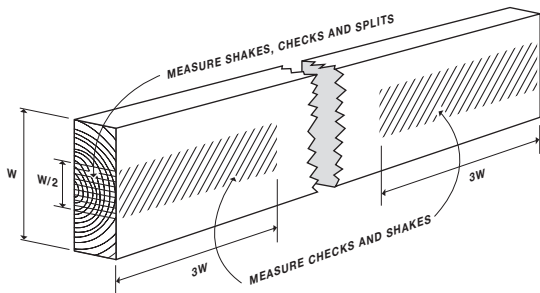

II. POSTS AND TIMBERS.

Shakes and checks, as a rule, have little influence on the strength of a post or column, unless so extensive as to split the piece practically in two. The grade limitations are applied primarily for appearance.

III. MEASUREMENT OF SHAKES, CHECKS AND SPLITS.

- (a) **SHAKES** in Structural Framing and Beams and Stringers are measured at the ends of pieces, between lines enclosing the shake and parallel to the wide faces.

SHAKES, CHECKS AND SPLITS

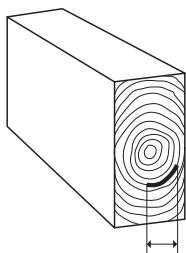

MEASURE SHAKE

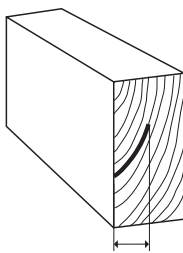

MEASURE SHAKE

- (b) **SHAKES** in Posts and Timbers are measured at the ends of pieces, between lines parallel with the two faces that give the least dimension. The size of shake permitted in a grade is for unseasoned lumber. If the lumber is seasoned, the size of shake may be 1-1/2 times the size permitted in a grade.

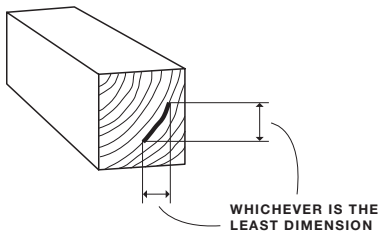

SHAKES, CHECKS AND SPLITS

- (c) **CHECKS** are measured as an average of the penetration perpendicular to the wide face. Where two or more checks appear on the same face, only the deepest one is measured. Where two checks are directly opposite each other, the sum of their depths is considered.

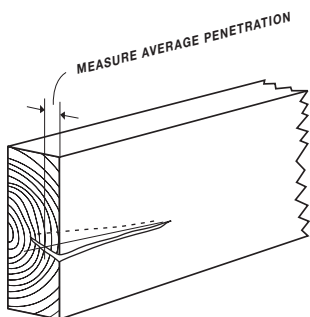

- (d) **SPLITS** are measured as the penetration of a split from the end of the piece and parallel to the edges of the piece.

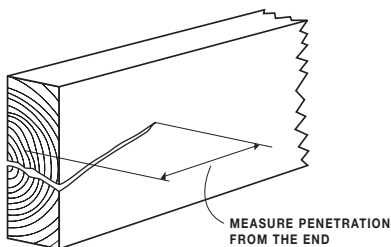

SLOPE OF GRAIN

203. Slope of grain is the deviation of the wood fiber from a line parallel to the edges of a piece. The deviation is expressed as a ratio such as a slope of grain of 1 in 8, 1 in 10, 1 in 12 and 1 in 15.

Slope of grain as measured is representative of the general slope of the fibers and local deviations are disregarded. Measurement of slope of grain should be over a sufficient length and area so that local deviations will not be misleading.

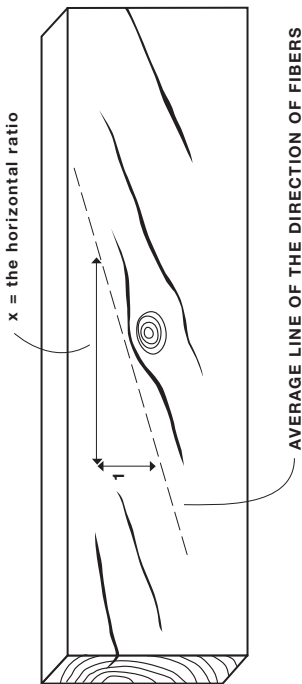

DENSITY & RATE OF GROWTH

(Any grade when specified)

204. The greater the specific gravity of lumber the greater is the strength of the wood fibers. Two methods of measuring specific gravity or density are available and are described in section 5.6 including sub-sections of ASTM D245-00. One method described herein is visually measuring the growth rings per inch along with the amount of summerwood in the growth rings.

Rate of growth requirements are sometimes a part of a grading rule for reasons of texture as well as strength.

204-a. "MEDIUM GRAIN" means an average of approximately 4 or more annual rings per inch on either one end or the other of a piece, measured as described in Para. 204-d. In Douglas fir, pieces averaging less than 4 rings per inch are accepted if averaging 1/3 or more summerwood - the dark portion of the annual ring.

204-b. "CLOSE GRAIN" means an average of approximately 6, but not more than approximately 30 annual rings per inch on either one end or the other of a piece, measured as described in Para. 204-d. In Douglas fir, pieces averaging 5 rings or more than 30 rings per inch, are accepted as close grain if averaging 1/3 or more summerwood.

204-c. "DENSE MATERIAL" in Douglas fir averages approximately 6 or more annual rings per inch and, in addition, 1/3 or more summerwood on either one end or the other of a piece, measured as described in Para. 204-d. The contrast in color between the summerwood and springwood must be distinct. Pieces averaging less than 6 annual rings per inch but not less than 4 are accepted as dense if averaging 1/2 or more summerwood.

204-d. MEASURING AVERAGE RATE OF GROWTH
Average rate of growth shall be made in such a way as to ensure that the measured radial line is representative. Measurement shall be made over a continuous length of 3" or as nearly 3" as is possible. The length shall be centrally located in side-cut (FOHC) pieces. In pieces containing the pith (boxed heart), the measurement may exclude an inner portion of the radius amounting to approximately one quarter of the least dimension.

RATE OF GROWTH

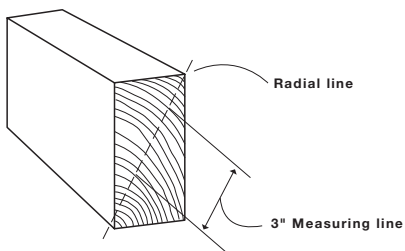

FOHC (SIDE CUT)

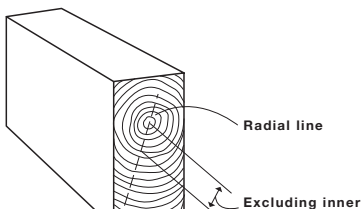

MACHINE STRESS RATED LUMBER ALL SPECIES

2" and Less in Thickness
2" and Wider

206-a. MECHANICALLY STRESS RATED LUMBER

Machine stress rated (MSR) lumber is lumber that has been evaluated by mechanical stress rating equipment. MSR lumber is distinguished from visually stress graded lumber in that each piece is nondestructively tested and marked to indicate the modulus of elasticity (E or MOE). MSR lumber is also required to meet certain visual requirements as set forth herein.

A grade stamp on Machine Stress Rated lumber indicates the stress rating system used meets requirements of the grading agency's certification and required quality control procedures. The grade stamp will show the agency trademark, the mill name or number, will include the phrase "MSR," the species identification and the "E" rating for the grade. The "E" rating is the rated average bending modulus of elasticity in millions of pounds per square inch for the grade when measured on edge (e.g. as a joist). Additionally, the grade stamp will include the fiber stress in bending value (Fb) and, when required, the allowable design tensile stress parallel to grain (Ft). The stamp will also include the Fv, Fc \perp , and long span E rating when the value is specifically qualified.

The "E" "Fb" grade combinations which can be qualified are not restricted to those combinations shown in Table 13. If the assigned allowable Ft is different for the MSR grade than that shown in Table 13 for the same Fb level, the assigned Ft value shall be included on the grade stamp. The remaining three assigned allowable properties (Fc, Fc \perp , Fv) for a grade shall be those listed for the equivalent Fb level. Higher values for Fv and Fc \perp may be assigned as described below.

For some uses it may be desirable to qualify and quality control a bending modulus of elasticity representative of different test conditions (e.g., long span MOE per Paragraph 154-d.) in addition to the standard edge bending MOE qualification for MSR. When the MSR grade is qualified and quality controlled for this specific MOE, the qualifying MOE value for the grade may be included as an additional mechanical property value for the grade. When so qualified, the MOE value must be included on the grade stamp.

MACHINE STRESS RATED LUMBER ALL SPECIES

A specific gravity value (based on oven dry weight/oven dry volume) higher than that listed in Table 14 may be assigned to a grade when the specific gravity of the grade is verified by test and controlled as part of the daily quality control program. When so qualified, the specific gravity value shall be included on the grade stamp.

The allowable stresses for compression perpendicular to grain and horizontal shear listed after Table 14 are appropriate for all grades. Compression perpendicular to grain ($F_{c\perp}$) and horizontal shear (F_v) have been shown to be well correlated with specific gravity. The equations given to calculate compression perpendicular to grain ($F_{c\perp}$) and horizontal shear (F_v) allowable stresses from specific gravity are based on that correlation. When the equations given, using the assigned grade specific gravity, produce higher allowable stresses for $F_{c\perp}$ or F_v than those assigned to all grades, the higher value may be used.

206-b. VISUAL GRADING REQUIREMENTS

Mechanically Stress Rated lumber must be well manufactured and visually graded to limit certain characteristics even though the actual strength is not affected. All pieces shall be visually graded to assure that the characteristics affecting strength are no more serious than the following limiting characteristics:

For grades 1000 Fb and above

Checks - seasoning checks not limited. Through checks at ends limited as splits.

Shake - if through at ends limited as splits. Away from ends through heart shakes up to 2' long, well separated. If not through, single shakes may be 3' or up to 1/4 the length, whichever is greater.

Skips - hit and miss, and in addition 5% of the pieces may be hit or miss or heavy skip not longer than 2'. See Para. 720(e), (f) and (g).

Splits - equal in length to 1-1/2 times the width of the piece.

MACHINE STRESS RATED LUMBER ALL SPECIES

Wane - $\frac{1}{3}$ thickness and $\frac{1}{3}$ width full length, or equivalent on each face, provided that wane not exceed $\frac{2}{3}$ thickness or $\frac{1}{2}$ the width for up to $\frac{1}{4}$ the length. See Para. 750.

Warp - light. See table, Para. 752.

Manufacture - standard "F." See Para. 722(f)

For grades below 1000 Fb.

Checks - seasoning checks not limited. Through checks at ends limited as splits.

Shake - surface shakes permitted. If through at edges or ends, limited as splits. Elsewhere through shakes $\frac{1}{3}$ the length, scattered along the length.

Skips - hit or miss, with a maximum of 10% of the pieces containing heavy skips. See Para. 720(e), and (g).

Splits - equal to $\frac{1}{6}$ the length of the piece.

Stain - stained wood - not limited.

Wane - $\frac{1}{2}$ thickness and $\frac{1}{2}$ width full length, or equivalent on each face, provided that wane not exceed $\frac{7}{8}$ the thickness or $\frac{3}{4}$ the width for up to $\frac{1}{4}$ the length See Para. 750.

Warp - medium. See table, Para. 752.

White Speck and Honeycomb - firm.

Manufacture - standard "F." See Para. 722(f).

MACHINE STRESS RATED LUMBER ALL SPECIES

In addition to the visual limitations listed, knots, knot holes, burls, distorted grain or decay partially or wholly at edges of wide faces, must not occupy more of the net cross-section than:

Fb Class

1/2 for 0 to 1000	1/4 for 1500 to 2050
1/3 for 1050 to 1450	1/6 for 2100 and over

Characteristics which occur in any end portion of the pieces which are not evaluated by the stress grading equipment shall be limited as follows:

Edge knots - Limited as listed above.

Non-edge knots - Equal to the largest non-edge knot in the tested portion of the piece or the next larger edge knot, whichever is greater. For 1/2 edge knot category, non-edge knot limited to 2/3 cross section.

Cross-section knots - Displacement of all knots in the same cross section must not exceed the size of the permitted non-edge knot.

Slope of grain - The general slope of grain in the untested end portion shall not exceed:

Slope	Fb Class
1 in 12	2100 and over
1 in 10	1500 to 2050
1 in 8	1050 to 1450
1 in 4	0 to 1000

MACHINE STRESS RATED LUMBER ALL SPECIES

TABLE 13

Machine Stress Rated Lumber: 2" or less in thickness - all widths Design Values, PSI, Normal Loading Grade Description Para. 206.			
Modulus of Elasticity E	Ex. Fiber in Bending Fb*	Tension Par. to Grain Ft	Comp. Par. to Grain Fc
1,000,000	900	350	1,050
1,200,000	1,200	600	1,400
1,300,000	1,350	750	1,600
1,300,000	1,450	800	1,625
1,400,000	1,250	800	1,475
1,400,000	1,500	900	1,650
1,500,000	1,200	600	1,525
1,500,000	1,650	1,020	1,700
1,600,000	1,650	1,175	1,700
1,600,000	1,700	1,175	1,725
1,600,000	1,800	1,175	1,750
1,700,000	1,950	1,375	1,800
1,800,000	1,800	1,200	1,750
1,800,000	2,100	1,575	1,875
1,800,000	2,250	1,750	1,925
1,900,000	1,950	900	1,825
1,900,000	1,950	1,375	1,825
1,900,000	2,250	1,750	1,925
2,000,000	1,800	1,175	1,750
2,000,000	2,250	1,750	1,925
2,000,000	2,400	1,925	1,975
2,000,000	2,700	1,800	2,100
2,100,000	2,550	2,050	2,025
2,200,000	2,500	1,750	2,000
2,200,000	2,700	2,150	2,100
2,300,000	2,850	2,300	2,150

For flatwise use, the modulus of elasticity (E) value listed in the table may be increased 100,000 psi for grades with assigned E greater than 1,300,000 psi, and 50,000 psi for grades with assigned E of 1,300,000 psi or less.

MACHINE STRESS RATED LUMBER ALL SPECIES

Note (Cont.)

Additional grades not listed may be qualified by test. When such grades are qualified, property values shall be rounded as indicated below. Compression parallel to grain (Fc) values may be interpolated based on assigned Fb.

Property	Rounding
Modulus of Elasticity (E)	100,000 psi
Fiber Stress in Bending (Fb)	25 psi below 1000 psi
	50 psi at 1000 psi and above
Tensile Stress Parallel to Grain (Ft)	25 psi
Compression Parallel to Grain (Fc)	25 psi

**MACHINE STRESS RATED LUMBER
ALL SPECIES**

**TABLE 14.
ASSIGNED SPECIFIC GRAVITY**

Species	Grade Modulus of Elasticity (psi)		Specific Gravity
Douglas Fir	Less than	2,000,000	0.50
		2,000,000	0.51
		2,100,000	0.52
		2,200,000	0.53
		2,300,000	0.54
		2,400,000	0.55
Hem-Fir	Less than	1,600,000	0.43
		1,600,000	0.44
		1,700,000	0.45
		1,800,000	0.46
		1,900,000	0.47
		2,000,000	0.48
		2,100,000	0.49
		2,200,000	0.50
		2,300,000	0.51
		2,400,000	0.52
S-P-F South	All Grades	0.36	
Western Cedars	All Grades	0.36	
Western Woods	All Grades	0.36	

1. Specific gravity basis is oven dry weight/oven dry volume. Higher values may be claimed, if specifically qualified and quality controlled, see Para. 206-a.
2. For imported species, see Para. 200-l.

MACHINE STRESS RATED LUMBER ALL SPECIES

Assigned –

Horizontal Shear (F_v)
for all stress levels:

Douglas fir	=	180 psi
Hem-Fir	=	150 psi
S-P-F S	=	135 psi
Western Cedars	=	155 psi
Western Woods	=	135 psi

Imported Species - Unless qualified by test, the assigned Horizontal Shear values for MSR lumber from imported species shall be equal to the value for the species assigned to visually graded lumber, see Tables 5c&d, para. 200-1.

When a grade is qualified by test and quality controlled for specific gravity, the allowable horizontal shear value may be calculated from the following formula:

$$F_v = 40 + (266 * \text{Sp. Gr.})$$

Note: Specific gravity is at oven dry weight and oven dry volume. Assigned values shall be rounded to the nearest 5 psi.

Values calculated from the equation above may be multiplied by 1.05 for MC 15 material.

Assigned –

Compression Perpendicular
to Grain ($F_{c\perp}$) for all stress levels:

Douglas fir	=	625 psi
Hem-Fir	=	405 psi
S-P-F S	=	335 psi
Western Cedars	=	425 psi
Western Woods	=	335 psi

Imported Species - Unless qualified by test, the assigned Compression Perpendicular to Grain values for MSR lumber from imported species shall be equal to the value for the species assigned to visually graded lumber, see

MACHINE STRESS RATED LUMBER ALL SPECIES

Tables 5c&d, Para. 200-L.

When a grade is qualified by test and quality controlled for specific gravity, the allowable compression perpendicular to grain value may be calculated from the following formula:

$$F_{c\perp} = (2252.4 * \text{Sp. Gr.}) - 480$$

Note: Specific gravity is at oven dry weight and oven dry volume. Assigned values shall be rounded to the nearest 5 psi.

Values calculated from the equation above may be multiplied by 1.16 for MC 15 material.

Compression perpendicular to grain values determined from the equation above are based on a 0.04 inch deformation limit and are for standard design of most structures.

Values at .02 inch deformation can be obtained with the following equations:

$$F_{c\perp} (.02) = (0.71 * F_{c\perp} .04) + 14.1$$

$$F_{c\perp} (.02) = (1605.5 * \text{Sp. Gr.}) - 327.5$$

Note: Specific gravity is at oven dry weight and oven-dry volume.

Unless qualified by test, the assigned Compression Perpendicular to Grain values for MSR lumber from imported species shall be the same value that was assigned the visually graded lumber, see Tables 5c & d, Para. 200-L.

MACHINE GRADED SCAFFOLD PLANK ALL SPECIES

207. There are three categories of machine graded scaffold plank, E-Rated Visual, E-Rated Machine Graded, and MSR. All categories of machine stress rating equipment. It is distinguished from visually graded scaffold plank in that each piece is nondestructively tested and marked to indicate the long span modulus of elasticity (E). E-rated Scaffold Plank grades shall be qualified and quality controlled in accordance with the requirements of the Bureau and the American Lumber Standard Committee, Inc. E-rated Scaffold Plank grades shall be marked to indicate the designated E-rated grade E in millions of pounds per square inch (psi).

207-a. E-RATED VISUAL SCAFFOLD PLANK.

Conforms to all provisions of Paragraph 171a, 171aa, 171b, or 171bb as applicable.

All pieces shall be mechanically E-rated by a process approved by the American Lumber Standard Committee Board of Review, and the Bureau.

The average long span modulus of elasticity of the E-rated grade shall be qualified by test and quality controlled. Only E-rated grades which equal or exceed the E-listed for the same visual grade and species as listed in Paragraph 200, Table 8a or 8b, may be qualified.

The 5th percentile tolerance limit (75% confidence) long span E for the grade shall equal or exceed 0.82 times the assigned average long Span E of the grade qualified.

The assigned extreme fiber in bending (Fb) shall be as specified in Paragraph 200, Table 8a or 8b, applicable for the visual grade and species.

E-Rated Scaffold shall be marked with an approved grade stamp which includes the agency logo, the mill identification, species, seasoning, the E-rated grade designation in millions of pounds per square inch (psi), and the applicable grade name as specified in Paragraph 171a, 171aa, 171b, or 171bb.

MACHINE GRADED SCAFFOLD PLANK ALL SPECIES

207-b. E-RATED MACHINE GRADED SCAFFOLD PLANK.

E-Rated Machine Graded Scaffold Plank is graded from Machine Stress Rated lumber which conforms to the provisions of Paragraph 206, combined with the E-rating and visual limitations of the Paragraph.

All pieces shall be mechanically E-rated by a process approved by the American Lumber Standard Committee Board of Review, and the Bureau.

The average long span modulus of elasticity of the E-rated grade shall be qualified by test and quality controlled. Only E-rated grades which equal or exceed the E-listed for the same grade and species as listed in Paragraph 200, Table 8a or 8b, may be qualified.

The 5th percentile tolerance limit (75% confidence) long span E for the grade shall equal or exceed 0.82 times the assigned average long span E of the grade qualified.

The assigned extreme fiber in bending (Fb) of the E-Rated Machine Graded Scaffold Plank shall be the assigned Fb of the MSR grade from which E-Rated Machine Graded Scaffold Plank is graded adjusted for flatwise use in accordance with Paragraph 200g, and rounded to the nearest 50 psi.

The following visual characteristics and limiting provisions are permitted:

Cup - light.

Holes - limited to 1/6 the width or 1-1/2 inches, whichever is smaller.

Knots - knots may be sound, unsound, or encased.

- Edge knots are measured and limited in accordance with Paragraph 206.
- Knots away from the edge (elsewhere knots) are limited in size to the next larger edge knot category.
- Surface spike knots are limited on wide face to 1/3 the width.
- Chipped or sloughed knots at the edge of the wide face are permitted, if not through the thickness.

MACHINE GRADED SCAFFOLD PLANK ALL SPECIES

Pitch Pockets - medium.

Pitch Streaks - medium.

Pith - pith (heart center) is permitted in all grades of machine graded scaffold.

Skips - light, hit & miss in a maximum of 10% of the pieces. See Paragraph 720f.

Shake - none through. Surface shakes up to 2' long.

Slope of Grain - limited to 1/15 for machines which do not evaluate slope of grain.

Wane - 1/3 the thickness and 1/10 the width for 1/4 the length, or equivalent except on the wide face.

Warp - light, except very light twist.

The ends of the lumber not tested by the stress grading equipment shall be limited as follows:

Knots

- Edge knots limited in accordance with Paragraph 206.

- Knots away from the edge (elsewhere knots) limited in size to the largest edge knot or non edge knot in the tested portion of the piece which ever is larger.

Slope of grain - limited to 1/12. Limited to 1/15 for machines which do not evaluate slope of grain.

E-Rated Machine Graded Scaffold Plank shall be marked with an approved grade stamp which includes the agency logo, the mill identification, species, seasoning with the applicable E-rated grade designation in millions of pounds per square inch (psi) and applicable flatwise Fb.

MACHINE GRADED SCAFFOLD PLANK ALL SPECIES

207-c. MACHINE STRESS RATED (MSR) SCAFFOLD PLANK.

Machine Stress Rated Scaffold Plank is graded to conform with all provisions of Paragraph 206, Machine Stress Rated Lumber, and the E-rating and visual limitations of the Paragraph.

All pieces shall be mechanically E-rated by a process approved by the American Lumber Standard Committee Board of Review, and the Bureau.

All MSR grades used to manufacture Machine Stress Rated Scaffold Plank shall be qualified and quality controlled in accordance with the provisions of Paragraph 206, and the Bureau Qualification and Quality Control Procedures for Machine Graded Lumber.

The average long span modulus of elasticity of the E-rated grade shall be qualified by test and quality controlled.

The 5th percentile tolerance limit (75% confidence) long span E for the grade shall equal or exceed 0.82 times the assigned average long span E of the grade qualified.

The assigned extreme fiber in bending (Fb) of a Machine Stress Rated Scaffold Plank grade shall be the assigned Fb for the MSR grade adjusted for flatwise use in accordance with Paragraph 200g, and rounded to the nearest 50 psi.

The following visual characteristics and limiting provisions are permitted:

Cup - light.

Holes - limited to 1/6 the width or 1-1/2 inches, whichever is smaller.

Knots - knots may be sounds, unsound, or encased.

- Edge knots are measured and limited in accordance with Paragraph 206.
- Knots away from the edge (elsewhere knots) are limited in size to the next larger edge knot category.
- Surface spike knots are limited on wide face to 1/3 the width.
- Chipped or sloughed knots at the edge of the wide face are permitted, if not through the thickness.

MACHINE GRADED SCAFFOLD PLANK ALL SPECIES

Pitch Pockets - medium

Pitch Streaks - medium

Pith - pith (heart center) is permitted in all grades of machine graded scaffold.

Skips - light, hit & miss in a maximum of 10% of the pieces. See Paragraph 720f.

Shake - none through. Surface shakes up to 2' long.

Slope of Grain - limited to 1/15 for machines which do not evaluate slope of grain.

Wane - 1/3 the thickness and 1/10 the width for 1/4 the length, or equivalent except on the wide face.

Warp - light, except very light twist.

The ends of the lumber not tested by the stress grading equipment shall be limited as follows:

Knots

- Edge knots limited in accordance with Paragraph 206.
- Knots away from the edge (elsewhere knots) limited in size to the largest edge knot or non edge knot in the tested portion of the piece which ever is larger.

Slope of grain - limited to 1/12. Limited to 1/15 for machines which do not evaluate slope of grain.

Machine Stress Rated Scaffold Plank shall be marked with an approved grade stamp which includes the agency logo, the mill identification, species, seasoning, the E-rated grade designation in millions of pounds per square inch (psi), the designation "MSR", and the applicable MSR E-f grade designation.

**MACHINE GRADED SCAFFOLD PLANK
ALL SPECIES**

Grade Stamp Facsimiles.

Para. 207-a

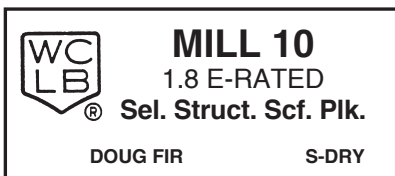

Para. 207-b

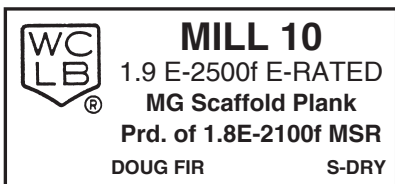

Para. 207-c

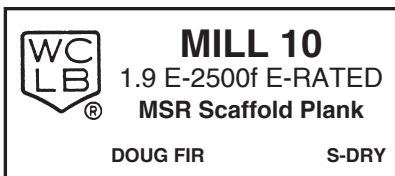

STRUCTURAL GLUED LUMBER

210. STRUCTURAL GLUED LUMBER (all species).

Glued lumber identified as structural glued lumber shall meet both the grade specifications of the grade rules under which the lumber is graded, and the glue bond requirements of this paragraph and the WCLIB Glued Lumber Certification and Quality Control Manual. Structural glued lumber identified by a Bureau structural glued quality mark shall be considered as a solid piece. Grade specifications and limitations for structural glued lumber are the same as for lumber without glue joints. The quality of the glue joints is considered a separate factor. Structural glued lumber shall be ordered, acknowledged, and invoiced as structural glued material

210-a. “CERTIFIED GLUED LUMBER”. All structural glued lumber identified by the Bureau Certification of Structural Glue Joint mark shall meet all the requirements of the rules under which it is graded, and all applicable requirements for end, face, and/or edge joints for exterior adhesives of American National Standard ANSI/AITC A190.1 for Structural Glued Laminated Timber. Adhesives used shall meet the requirements of ASTM D2559.

210-b. “CERTIFIED END JOINT”. All end jointed material identified by the Bureau Certification of End Joint mark shall meet all the requirements of the rules under which it is graded, and all applicable requirements for end joints using exterior adhesives of American National Standard ANSI/AITC A190.1 for Structural Glued Laminated Timber. Adhesives used shall meet the requirements of ASTM D2559.

Grade Stamp
Facsimile.



STRUCTURAL GLUED LUMBER

MAXIMUM PERMITTED KNOT SIZE IN END JOINT AREA

Nom. Width	CERTIFIED END JOINT			
	Select Structural	No. 1	No. 2	No. 3 (and Lt. Frm. Grades*)
2"	3/16"	1/4"	1/4"	3/8"
3"	1/4"	3/8"	1/2"	5/8"
4"	3/8"	1/2"	3/4"	7/8"
5"	1/2"	5/8"	7/8"	1-1/8"
6"	5/8"	3/4"	1"	1-3/8"
8"	3/4"	1"	1-1/8"	1-5/8"
10"	1"	1-1/8"	1-3/8"	1-7/8"
12"	1-1/4"	1-1/4"	1-1/2"	2"

* Lt. Framing Grades are 4" nominal width and less.

210-c. "STUD USE ONLY". End jointed lumber manufactured with adhesives meeting all the provisions of ASTM D2559 for exterior adhesives with the exception of creep (Section 16), may be stamped with "STUD USE ONLY" end joint stamps. "STUD USE ONLY" end jointed lumber is limited to 6" and less in nominal width and 12' and shorter in length.

MAXIMUM PERMITTED KNOT SIZE IN END JOINT AREA

Nom. Width	STUD USE ONLY		
	Select Structural	No. 1, No. 2, Const.	Stud, No. 3, Stand., Utility
2"	1/4"	1/4"	3/8"
3"	3/8"	1/2"	3/4"
4"	1/2"	5/8"	1"
5"	5/8"	3/4"	1-1/4"
6"	3/4"	7/8"	1-1/2"